

NEWSTRIPES INC.

ATHLETIC FIELD MAINTENANCE 2024



PROUDLY MADE IN THE USA SINCE 1981

MANUFACTURING

Ralph Newman founded Newstripe, Inc. in 1981. The first factory was his garage and the first products were simple, inexpensive striping machines.

From that humble beginning **Newstripe™** has grown to a comprehensive product design and development company manufacturing more than 50 different machines and over 2000 stencils.

And yes, we still manufacture all our products in Aurora, Colorado. We are proud to label our products **“MADE IN AMERICA”**



Newstripe LINERIDER™



Item# 10003033

Newstripe, Inc. is pleased to introduce the revolutionary **LineRider™** UTV mounted field striping and marking machine. Simply slide it into your current UTV's bed, plug in the power cord, and you have fastest, most durable, and economical riding field striping machine available. No more pushing a walk behind striper for miles a day. Just sit in the comfort of your UTV, and let it do the work for you.

For Use with All Athletic Bulk Paints – Accommodates all athletic bulk paint, whether it be thick, thinned, or temporary paint. No more paying extra for expensive proprietary, boxed paint. Choose whatever paint works for your application.

Reduce Paint Budget – The fully adjustable, 0-3000 psi airless paint pump allows you to select the best pressure to perfectly apply your paint, regardless of the type of field surface that is being painted.

Fast – Stripe up to 9 mph. That's three times faster than typical walk behind stripers.

Economical – Priced at less than \$7000 the LineRider UTV has features unavailable on any other field striping machine.

Fits on most popular UTVs – John Deere, Kabota, Ranger.

Easy Installation and Removal – Quickly slides into the bed of a UTV. The power cord simply plugs into the UTV, and you are ready to stripe. It is that easy and takes less than ten minutes. Need to use your UTV for other jobs? No problem. Removal is as easy and quick as the installation. The total weight of the LineRider is less than 180 pounds which allows it to be handled by as little as two people.

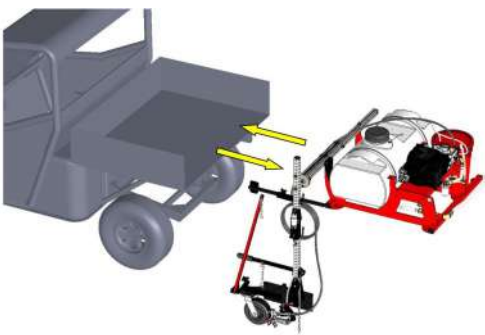

Newstripe NewRider™ 5000



Item# 10003033

- Built to handle the demands of medium to large size athletic field complexes.
- Rear wheel steering for tighter turning radius and increased maneuverability. Stripe 2"-6" wide lines
- Convenient foot operated controls provide maximum command of the airless spray system from the comfort of the driver's seat.
- The innovative lower deck height design optimizes the operators line of sight for straighter and more accurate lines.
- The generous **50-gallon** poly tank stripes 3 football fields or 6 soccer fields with just one fill. Plus, the onboard purge tank makes clean up a snap.
- System pressure gauge and hour meter to help keep your machine maintained and running properly.

Newstripe NewRider™ 1700



Item# 10004026

- The perfect solution to quickly paint small to medium size sports facilities.
- Encompasses reliable airless spray technology and unsurpassed quality construction for years of dependable operation. Stripe 2"-6" wide lines.
- The integrated 2.5 gallon purge tank cleans the spraying system to eliminate clogged spray gun and hoses.
- Compact design with low center of gravity provides increased stability and control.
- The 25-gallon poly tank stripes an entire football field or up to 3 soccer fields without the inconvenience of stopping to refill paint.
- System pressure gauge and hour meter to help keep your machine maintained and running properly.

Newstripe 4600™ SP Self-Propelled



Item# 10003031

All the great features of the model 4400™ plus:

- No more pushing with the easy to use variable speed friction drive self propelled system allowing for effortless striping and increased operator control.
- Add the optional rear caster for effortless circles and arcs. (also available on the 4400 and 4250)
- Add the optional cleaning tank for fast and easy cleanup. (also available on the 4400 and 4250)

Newstripe 4400™ Airless Walk Behind



Item# 10003566

- The four wheel design provides straighter lines and the OHV engine with Oil Alert increases long term dependability.
- Fully adjustable 0-3000 psi pump lets you spray perfect lines without wasting paint.
- Handle mounted controls let you quickly and efficiently stripe 2"-6" wide lines.
- Quickly remove the spray gun to paint stencils and hard to reach areas.

Newstripe 4250™ Airless Walk Behind



Item# 10003947

- Newstripe's most economical high pressure airless striper.
- Stripe professional quality 2" - 6" wide lines on both smooth and uneven surfaces.
- The lightweight design makes it easy to push across the roughest athletic fields.
- Built with proven airless technology that is both dependable and easy to use.
- Removable gun with 25 foot hose for painting stencils.

EcoLiner™ SP Field Striping Machine



Item# 10004621

- Easy to maintain and clean low pressure system.
- 12 foot hose for stencils or hard to reach areas.
- Pro-series Briggs and Stratton engine with oil alert eliminates the chance of oil starvation.
- No more pushing with the easy to use variable speed friction drive system allowing for effortless striping and increased operator control.
- Optional cleaning tank for fast and easy cleanup on the field.

EcoLiner™ LT Field Striping Machine



Item# 10005159

- At 82 lbs it is engineered for weight savings, allowing one person to load and unload from a vehicle and easy to push on the field.
- 5-gallon standard pail makes for quick and easy cleanup and color changes. Recirculating pump keeps paint mixed while striping.
- All welded steel construction and quality components mean years of quality service.
- Detachable spray gun with 12 foot hose to paint stencils or hard to reach areas.

EcoLiner™ Plus Battery Powered Field Striper



Item# 10004484

- Equipped with a rapid charge 120 volt plug in battery charger.
- Onboard clean water reservoir for instantaneous purging of the spraying system.
- Detachable spray gun with 10 foot hose. Sprays 2"-6" wide lines.
- 10" Flat free tires easily roll over uneven turf.

FieldLiner 3™



Item# 10004867

- Ideal for those on a tight budget who want to step up from aerosol can markers and save money by using bulk paint.
- The side mounted spray head adjust from 2 inch to 6 inch wide lines and can be removed to spray stencils.
- A built in hand pump pressurizes the paint.
- The full loop handle adjust to two different height positions and folds to fit easily into car trunk or SUV.
- Shown with optional CO2 Power pack.

CO2 Power Pack Item # 10004869

NewLiner™ HD 50 lb & 100 lb Dry Line Marker



Item# 10001744 & 10001745

- Made with galvanized steel material containers to prevent rusting. Line sight window in rear frame.
- Dual welded structural steel handles and chassis make for the most durable heavy-duty dry line field marker available. Made in the USA.
- Lever and rod with positive stop plate for precise 2 inch or 4 inch wide lines. 50lb or 100lb models.
- The four wheel design and 10" flat free tires provide straighter and more accurate lines.

NewLiner™ 25 Lb Dry Line Marker



Item# 10001300

- The original **American Made** infield chalker.
- Oversized foam rubber handgrips for increased operator comfort.
- 8 inch semi-pneumatic tires.
- Precision control for 2" or 4" wide lines
- The folding handle makes it easy to transport the machine between fields in car trunk or SUV.

DirtDoctor™ Infield Drag & Groomer



Item# 10003679

- Designed for use with 4-wheel drive utility vehicles or tractors with 1,100lb min towing capacity.
- Plow, pulverize, drag, and compact in just one pass.
- Quickly adjusts to your infield grooming needs without needing any tools. 48” wide cutting path.
- Maintain the perfect playing surface with multiple height positions and pulverizing depths up to 3 inches .
- Adjustable towing height.

DirtMedic™ Infield Drag & Groomer



Item# 10003315

- Designed for use with garden tractors, lightweight utility vehicles and ATV’s.
- Designed to fill, level, and finish infields in a single pass. 42” wide cutting path. 60” wide brush.
- Quickly adjusts to your desired grooming depth.
- The attached finishing brush effortlessly grooms the playing surface and provides an attractive finish to your infield.

DragKing™ Infield Drag & Groomer



Item# 10001592

- For use with light weight utility vehicles and ATV’s.
- Features a flexible 3-section component design that adjust for different levels of grooming.
- Combines the aggressive field conditioning benefits of heavier tractor pulled equipment with the freshly groomed finish of hand pulled drags.
- Scarifier cuts up to 1” deep or simply flip over or remove for finishing. 48” wide cutting path.
- Remove high spots or fill in low areas.

DragLite™



Item# 3 foot 10004485
Item # 6 foot 10004486

- May be pulled by hand or lawn tractor and features a unique flip over design.
- 11 gauge lead bar has a serrated edge to scarify surfaces or simply flip over for a mat only finish.
- Mat won't kink or rust.
- Built with Reinforced rubber and industrial grade material.
- Available in 3ft and 6ft wide models.

Custom Field Mascot Stencils

Quickly and easily paint multicolored mascot stencils. These stencils allow for precise transfer of your custom image to a variety of surfaces and are reusable.



Contact us to find out about making your logo or mascot into a stencil.

HashMark™ Master II



- No need for repeated measuring or using stencils and templates that require a two or three man crew.
- Uses your stripers spray gun so there is no need for additional tools or accessories. Creates a 24" hash mark.
- Follow the automatic measuring guide from one hash mark to the next, paint it and move on.
- Five times faster than other methods
- US Patent #7.367.515.B1



Low pressure: Eco-liiner modes. Item #10004801

High pressure: 4250, 4400,4600 modes. Item #10004800

HashMark™ Master II—S100/3400

S100/Item# 10004868



- Specifically designed for use with the Graco® S100 field striping machine. Creates a 24" hash mark.
- One person can easily paint hash marks five times faster than other methods. No measuring or templates required.
- Uses Graco's own spray gun so there is no need for additional tools or accessories.
- Follow the automatic measuring guide from one hash mark to the next, paint it and move on.



3400/Item# 10004868



HashMark™ Paint and Go



- Fast, inexpensive and simple to use.
- Rear mounted flip up hash mark stencil.
- Pays for itself the first time you use it.
- Mounts on any Newstripe walk behind striper.
- Easy to clean insert effortlessly creates 18"-24" hash marks.

Item# 10004850



ProLine™ Field Layout Systems



- Kits for All Sports: Football, Soccer, Baseball... They come complete with starting tool and 600 feet of high-grade cord.
- No open holes to catch players' shoe cleats or fill with debris.
- Made from super tough nylon the ProLine™ layout system will last for years.
- Three year warranty.

Baseball:	12 piece	Item# 10002719
Soccer:	25 piece	Item# 10002718
Football:	50 piece	Item# 10002717
Replacements:		Item# 10002723



SafeMark™ Field Layout Systems



- Unlike hard plastic markers, athletic shoes and cleats will not skid or catch on the SafeMark™ markers. Plus, they have no surface holes to trip players or fill with debris.
- May be used within the field of play.
- Plastic wings fold and lock markers in place
- Markers will not “back out“ from sprinklers, rain or temperature.
- Made from UV protected PolyFoam.
- Three year warranty.

12 piece	Item# 10001491
25 piece	Item# 10001492
50 piece	Item# 10001493
Replacements:	Item# 10001194

PolyTough™ Football Field Stencils

NCAA Hash Mark

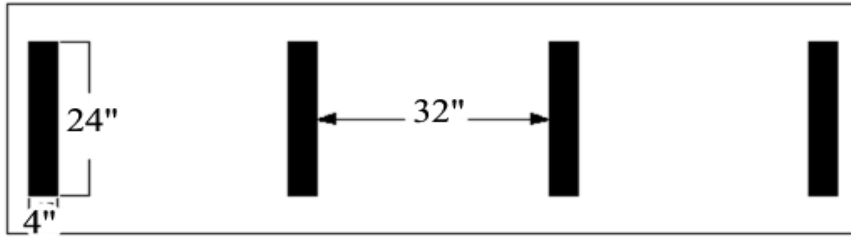

Item# 10001725

NCAA Football Kit

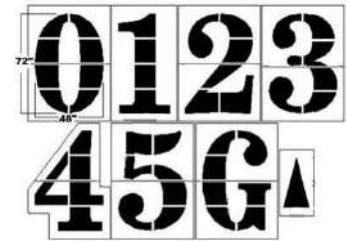

Item# 10001724

Hash Mark

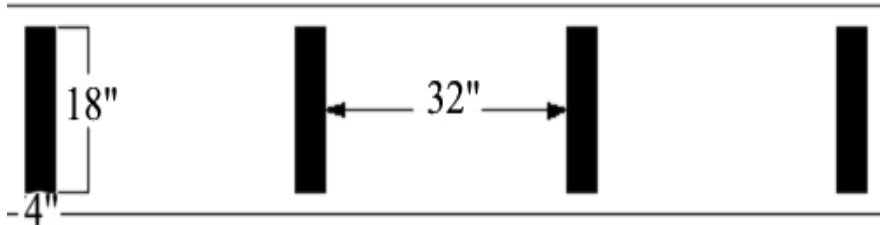

Item# 10000223

72 Inch Football Kit

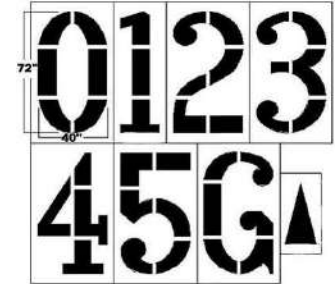

Item# 10000222

Deluxe Hash Mark

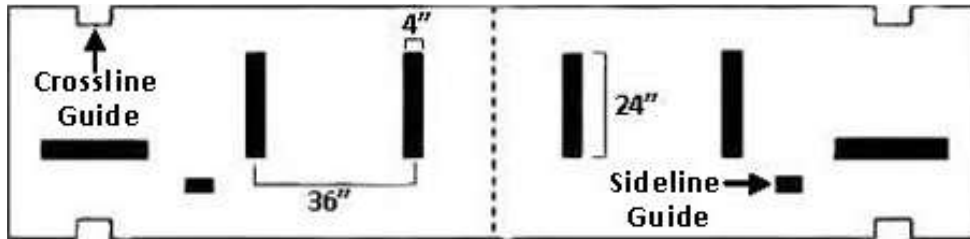

Item# 10003654

36 Inch Football Kit

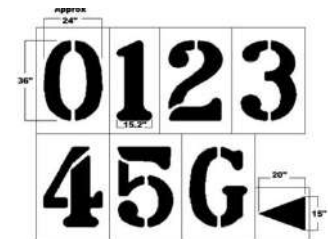

Item# 10000977

72 Inch Football Individual Numbers (0-5)

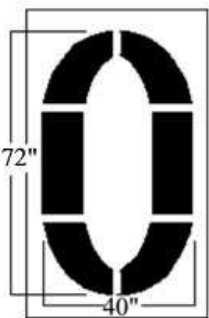

Item# 10001709

72 Inch Football Directional Arrow

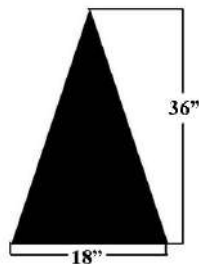

Item# 10001843

72 Inch Football "G"

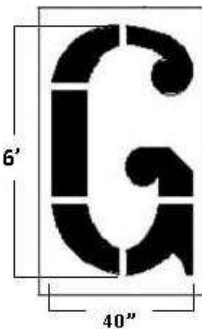

Item# 10001842

72 Inch Bold Block Letters

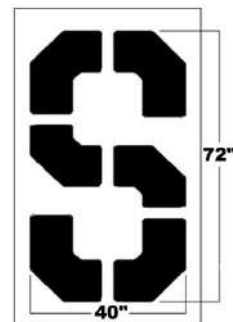

Item# 10001006

72 Inch Breast Cancer Ribbon



Item# 10004451

PolyTough™ Playground Stencils

NCAA Basketball Court

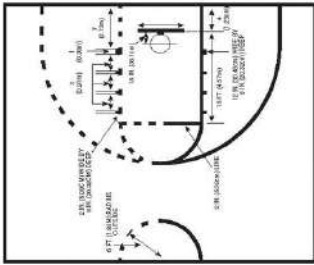

Item# 10003330

NCAA Basketball Court Key

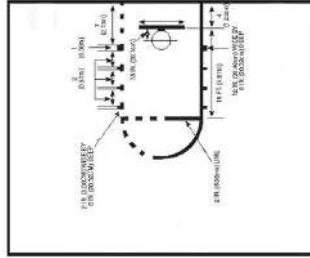

Item# 10003145

NCAA Basketball 6 Foot Center Circle



Item# 10003149

NCAA Basketball 3 Point Line

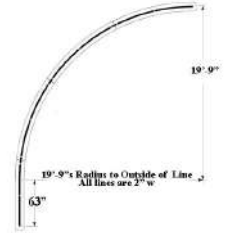

Item# 10003323

US Map

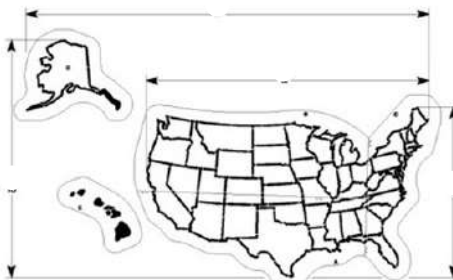

Small Item # 10001728
Medium Item# 10003676
Large Item# 10001727

Four Square

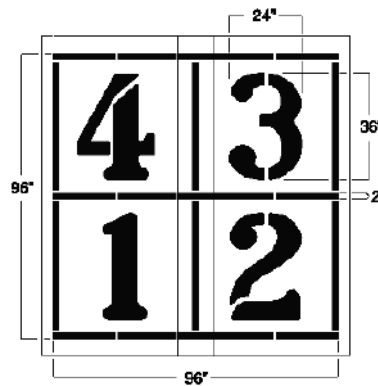

Item# 10001726

Snail Hopscotch

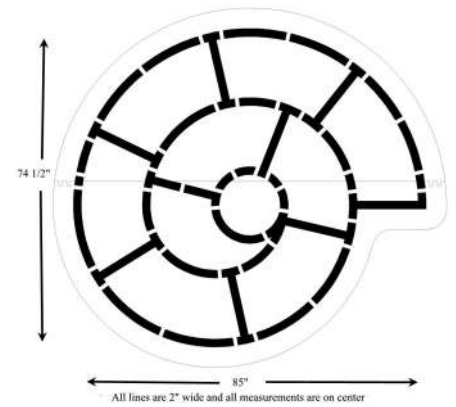

Item# 10003386

Traditional Hopscotch

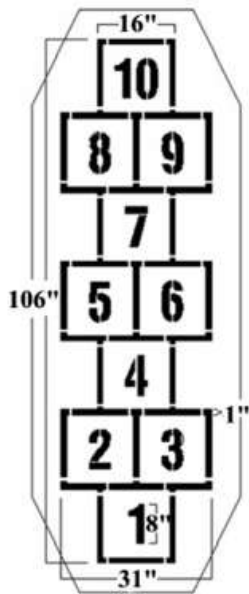

Item# 10003336

Arched Hopscotch

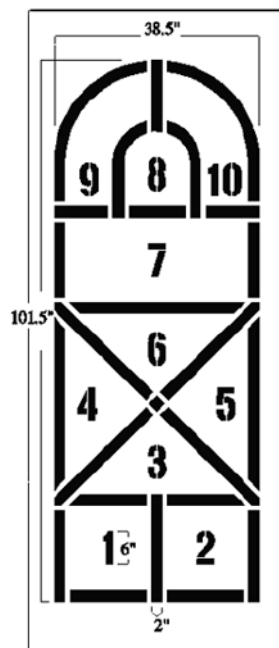

Item# 10000448

Shuffle Board

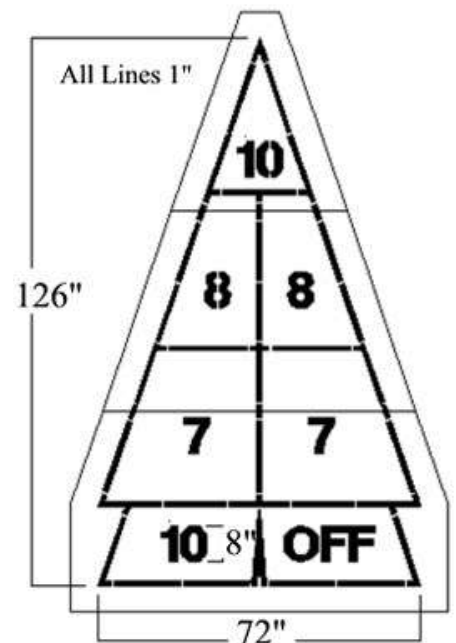

Item# 10001729